

Product Information

DT437 2-Wire indoor Monitor



DESCRIPTION

2-wire system 4.3 inch color TFT monitor.

DIMENSION

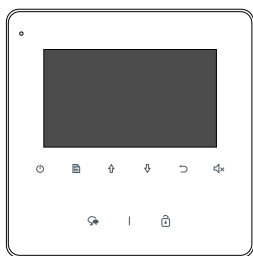

137



17

FEATURES

- 4.3" colour TFT screen
- White housing with plexiglass front panel
- Touch sensor button
- Hands-free communication
- Magnetic bracket mounted
- Slim&ultra thin design
- Telephone entry extension via IPG unit
- Staircase light control via RLC unit
- Multi-languages supported
- Compatible with all DT two wire system models

* Multi languages operation(customized)



1. Parts and Functions

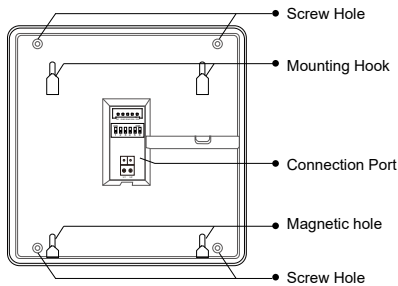
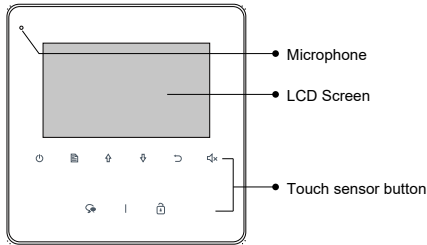

Touch sensor button

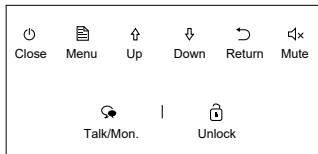

Key Functions

Microphone	Receives sound from the user
LCD screen	Display the images from outdoor station
Close key	Press to shut off the screen
Menu key	Press to open a list of actions available on the current screen
Up key	Scrolls through lists and moves the cursor
Down key	
Return key	Press to return to last menu
Mute key	Press to open a list of mute function option
Talk/Mon. key	<ol style="list-style-type: none"> Press to talk with the visitors while receiving a call Press to monitor outdoor in standby
Unlock key	Press to release the door for visitors during talking or monitoring
Speaker	Output sound from the outdoor

2. Terminal Description

L1,L2: Non-polarity bus line.

SW+,SW-: Doorbell call button connection port.

Ring,GND: Extra buzzer connection port.

NG: Reserved.

DIP switches: Total 6 bits can be configured.

Bit1~Bit5: User Code setting switch.

Bit6: Video impedance matching switch.

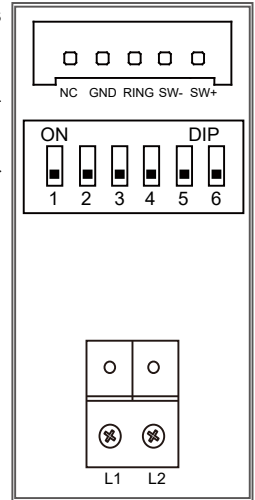

3. Mounting

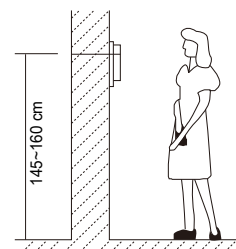
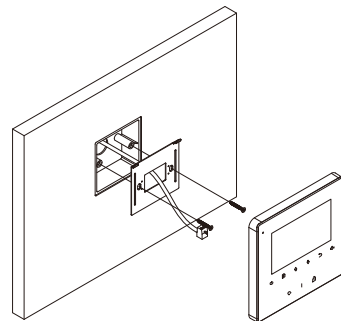



4. Specification

Power Supply: DC 20~28V
 Consumption: Standby 0.17W;
 Working 4.7W
 Screen: 4.3 inch digital color TFT
 Resolutions: 480 X 272 pixels
 Video Signal: 1Vp-p, 75Ω, CCIR standard
 Wiring: 2 wires, non-polarity
 Dimension: 137(H)×137(W)×17(D)mm

5. Ordering Information

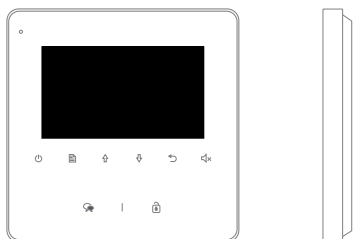

Model No.	Description	Menu style
DT437/D4	4.3 inch color TFT monitor with touch sensor button & plexiglass panel	Text menu

6. Optional Accessories (Not included)

Item	Brief Description	Remark
DB1-W	Desk top bracket in white color	For desktop mounting
DB1-B	Desk top bracket in black color	For desktop mounting

7. Packing Information

Single Package



Dimensions: 155(H)×142(W)×28(D)mm

Gross Weight: 0.29Kg

Carton Package



Carton: 325 (H)×298 (W)×380 (D)mm

Quantity: 48PCS

8. Menu Style

